

ZWD306EC spare parts list

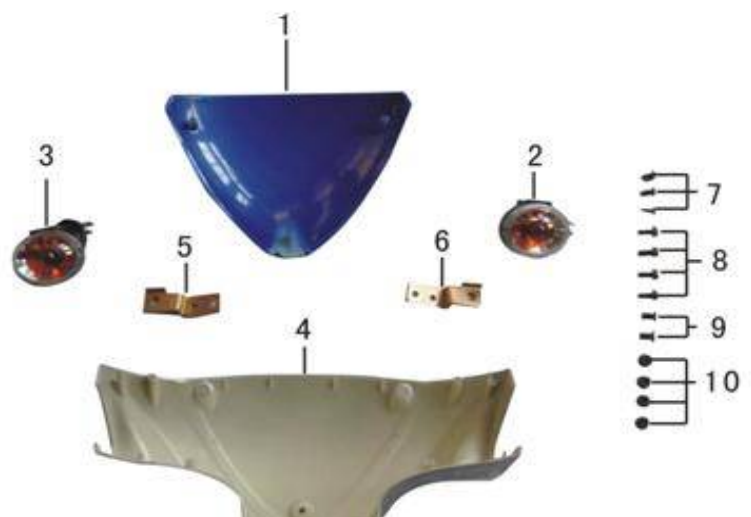

ZWD306 spare parts list

A: front cover, decoration, front turning lights





No.	Code	Description	quantity
1	ZW-A-01	front cowl sheet	1pc
2	ZW-A-02	front right turning light	1pc
3	ZW-A-03	front left turning light	1pc
4	ZW-A-04	front cowl	1pc
5	ZW-A-05	supporting nog	1pc
6	ZW-A-06	supporting nog	1pc
7	ST4.2×10	screw	3pc
8	M5×12	bolt flangle	4pc
9	M6×12	bolt	2pc
10	M5	flangle nut	4pc

B: meter, meter cowl



No.	code	description	quantity
1	ZW-B-01	meter	1pc
2	ZW-B-02	meter cowl	1pc
3	ST4.2×13	screw	3pc

C: Luggage box cover, charging socket

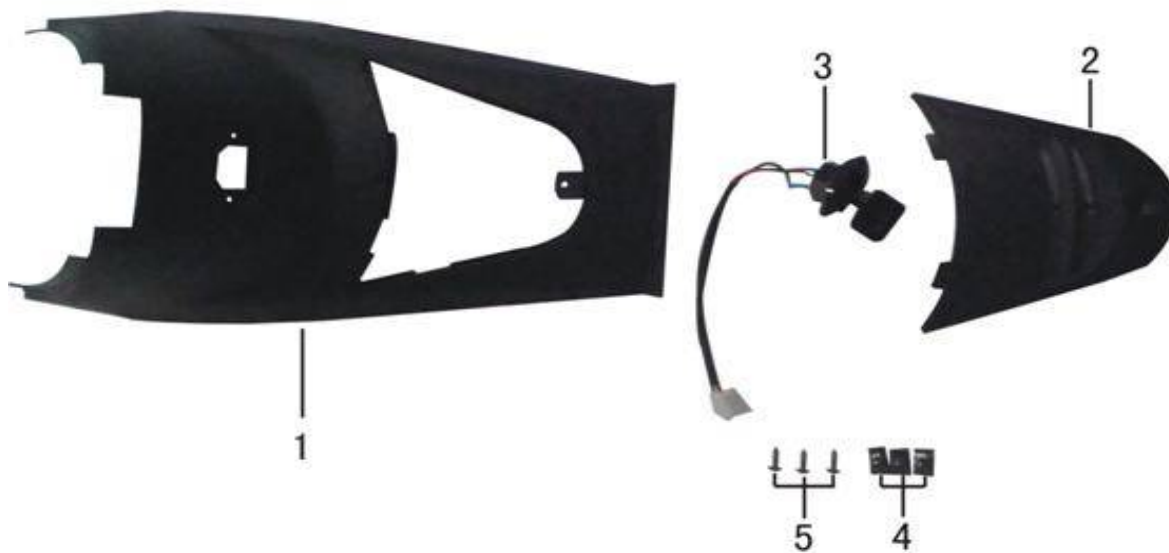

No.	code	description	quantity
1	ZW-C-01	Luggage box cover F	1pc
2	ZW-C-02	small shell on ZW-C-01	1pc
3	ZW-C-03	charging socket	1pc
4	ST4.2	nut spring	3pc
5	ST4.2x16	screw	3pc

D: Lacquers, side-fenders, tail light

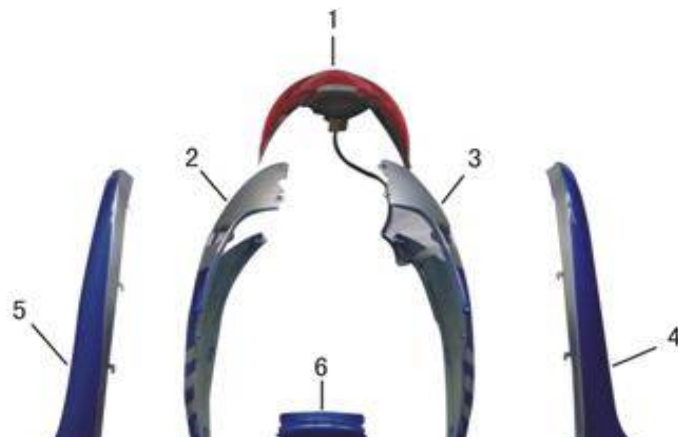



No.	code	description	quantity
1	ZW-D-01	tail light	1pc
2	ZW-D-02	right lacquer	1pc
3	ZW-D-03	left lacquer	1pc
4	ZW-D-04	rear left side-fender	1pc
5	ZW-D-05	rear right side-fender	1pc
6	ZW-D-06	rear fender	1pc
7	ST4.2	nut spring	1pc
8	ST4.2×13	screw	4pc
9	ST4.2×10	screw	4pc

E: Pedal board assy



No.	code	description	quantity
-----	------	-------------	----------

1	ZW-E-01	pedal board	1pc
2	M6x10	bolt	4pc

F: front side-fenders, wash board, battery b

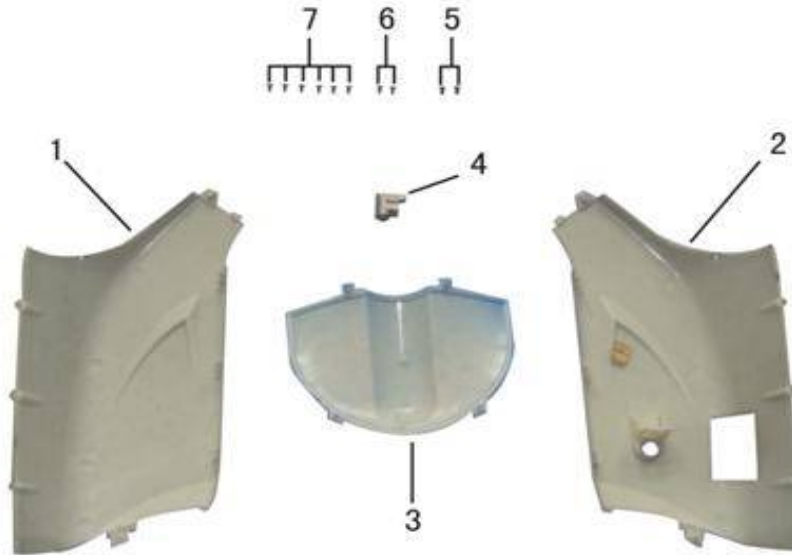

No.	code	description	quantity
1	ZW-F-01	front right side-fender	1pc
2	ZW-F-02	front left side-fender	1pc
3	ZW-F-03	wash board	1pc
4	ZW-F-04	battery box lock	1pc
5	M5x10	bolt	2pc
6	ST4.2x13	screw	2pc
7	ST4.2x13	screw	6pc

G: rear mud-fender, plate, rear turning lid

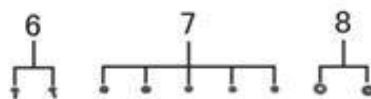



No.	code	description	quantity
1	ZW-G-01	rear mud-fender	1pc
2	ZW-G-02	plate	1pc
3	ZW-G-03	rear left turning light	1pc
4	ZW-G-04	rear right turning light	1pc
5	ZW-G-05	reflector	1pc
6	M6x12	bolt flange	2pc
7	M6	flange nut	5pc
8	f 6xf 18x1.5	washer	7pc

H: handlebar, brake bar, throttle, grip, coi



No.	code	description	quantity
1	ZW-H-01	handlebar	1pc
2	ZW-H-02	left combined switch	1pc
3	ZW-H-03	throttle	1pc
4	ZW-H-04	left grip	1pc
5	ZW-H-05	left brake bar	1pc
6	ZW-H-06	right brake bar	1pc
7	M10x1.25x50	bolt flange	1pc
8	ZW-H-08	handlebar lock	1pc
9	M10	flange nut	1pc

I: front luggage box, VIN number cover



No.	code	description	quantity
1	ZW-I-01	front luggage box	1pc
2	ZW-I-02	VIN number cover	1pc
3	M6x40	bolt flange	1pc
4	f 6xf 18x1.5	washer	1pc

J: switch

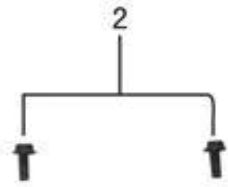

No.	code	dexcription	quantity
1	ZW-J-01	switch	1pc
2	M6x16	bolt glangle	2pc

K: Luggage box, seat

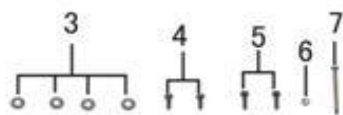

No.	code	description	quantity
1	ZW-K-01	seat	1pc
2	ZW-K-02	luggage box	1pc
3	f 6xf 18x1.5	washer	4pc
4	M6x12	bolt flange	2pc
5	M6x16	bolt flange	2pc
6	M6	bolt	1pc
7	M6x65	bolt	1pc

L: rear box, rear box lock



No.	code	description	quantity
1	ZW-L-01	underside rear box	1pc
2	ZW-L-02	upside rear box	1pc
3	ZW-L-03	rear box cushion	1pc
4	ZW-L-04	rear box lock	1pc
5	ZW-L-05	lock cover	1pc
6	ZW-L-06	decoration plate	1pc
7	ZW-L-07	washer	1pc
8	ZW-L-08	hook	1pc

9	M6	screw cap	3pc
10	M6x12	bolt flange	2pc
11	M6x12	bolt flange	1pc
12	ST3.5x10	screw	2pc
13	ST4.2x13	screw	6pc
14		plug	2pc

M: motor, front wheel, drum brake

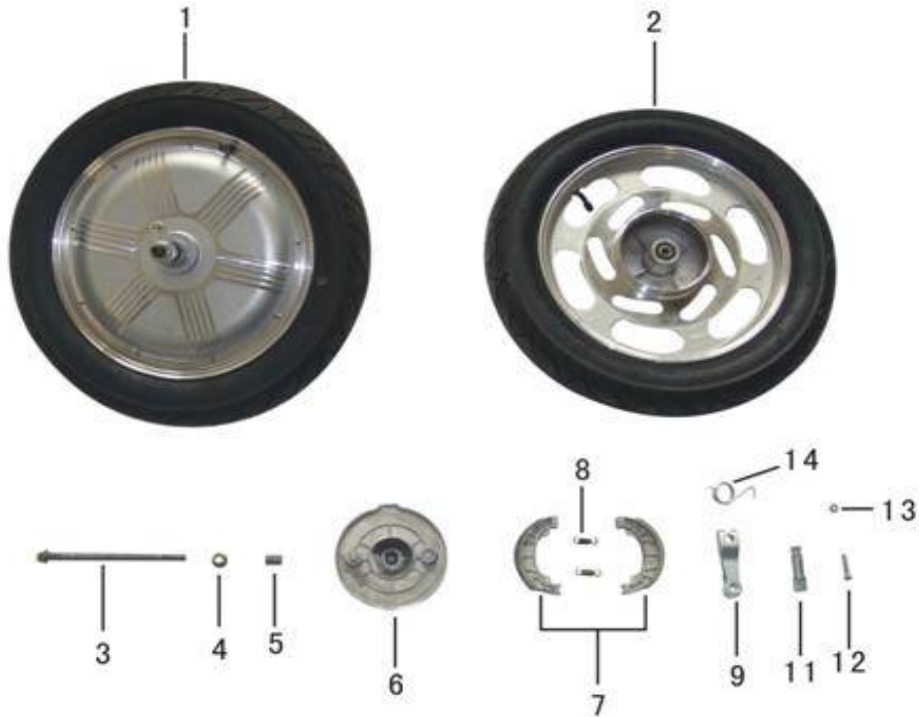

No.	code	description	数量
1	ZW-M-01	rear wheel assy(16x3.0)	1set
2	ZW-M-02	front wheel assy(16x3.0)	1set
3	M10x1x180	front axle	1pc
4	M10x1	flange nut	2pc
5	φ 10x φ 14x20	front wheel spacer	1pc
6	ZW-M-06	brake hubcap	1pc
7	ZW-M-07	brake shoe	2pc
8	ZW-M-08	brake block spring	2pc
9	ZW-M-09	brake rocker	1pc
11	ZW-M-10	brake rocker axle	1pc
12	M6x20	bolt	1pc
13	M6	screw cap	1pc
14		block spring	1pc

N: rear fork



No.	code	description	quantity
1	ZW-N-01	rear fork	1pc
2	M12x1.25x75	rear fork axle	1pc
3	M12	nut spring	1pc
4	M12x1.25	flange nut	1pc

O: frame



No.	code	description	quantity
1	ZW-O-01	frame	1pc

P: front absorb, front fender, 前减震、前泥板

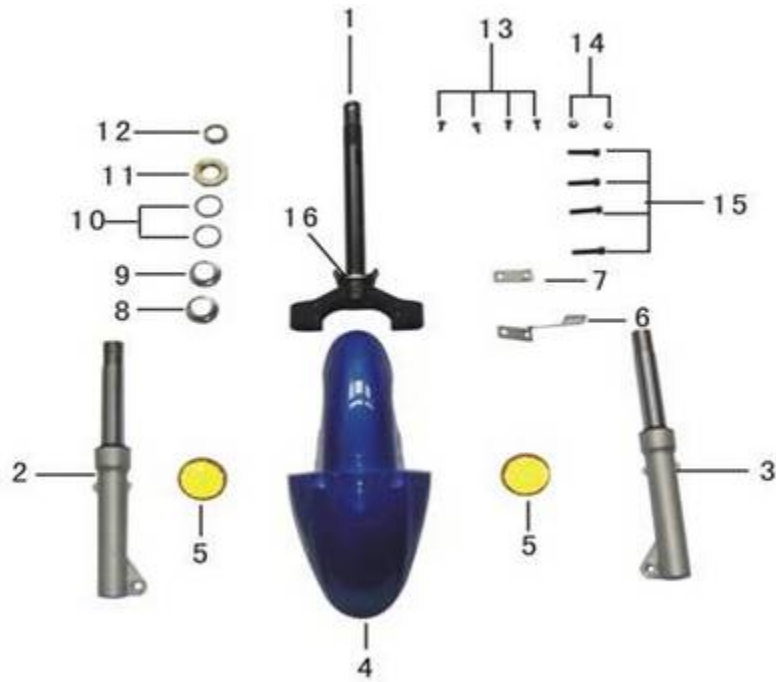

No.	code	description	quantity
1	ZW-P-01	front absorb stem	1pc
2	ZW-P-02	left absorb	1pc
3	ZW-P-03	right absorb	1pc
4	ZW-P-04	front fender	1pc
5	ZW-P-05	side reflector	2pc
6	ZW-P-06	left supporting nog	1pc
7	ZW-P-07	right supporting nog	1pc
8	ZW-P-08	under steer racer	1pc
9	ZW-P-09	up steer racer	1pc
10	ZW-P-10	steer bearing	1pc
11	ZW-P-11	up steer socket	1pc
12	ZW-P-12	block screw	1pc
13	M6x12	bolt flange	4pc
14	M6	flange nut	2pc
15	M6x16	bolt	4pc
16	ZW-P-16	under steer socket	1pc

Q: wires, controller, converter, flasher, h



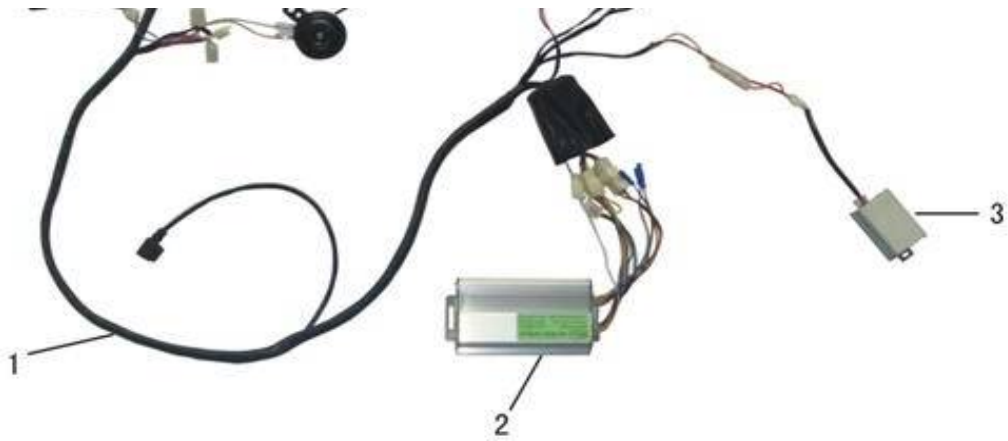

No.	code	英文名称	数量
1	ZW-Q-01	wire	1pc
2	ZW-Q-02	controller(48V 650W)	1pc
3	ZW-Q-03	converter(48V/12V)	1pc
4	ZW-Q-04	flasher(12V)	1pc
5	ZW-Q-05	horn(12V)	1pc

R: seat lock plate

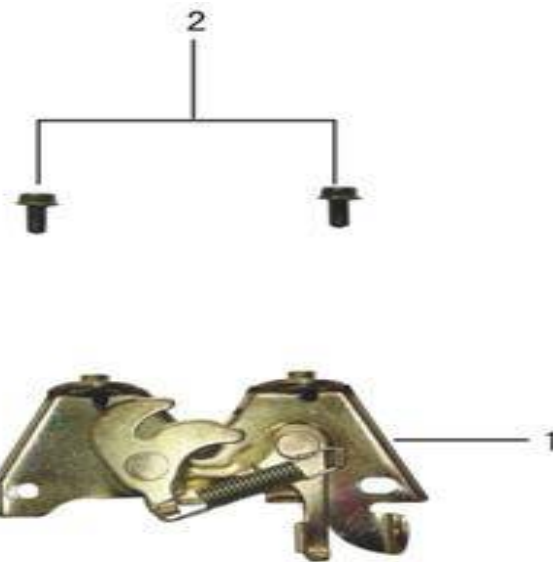

No.	code	description	quantity
1	ZW-R-01	seat lock plate	1pc
2	M6x12	bolt flange	2pc

S: rear mud-fender



No.	code	description	quantity
1	ZW-S-01	rear mud-fender	1pc
2	M6x10	bolt flange	1pc
3	f 6xf 18x1.5	washer	1pc

T: rear absorb

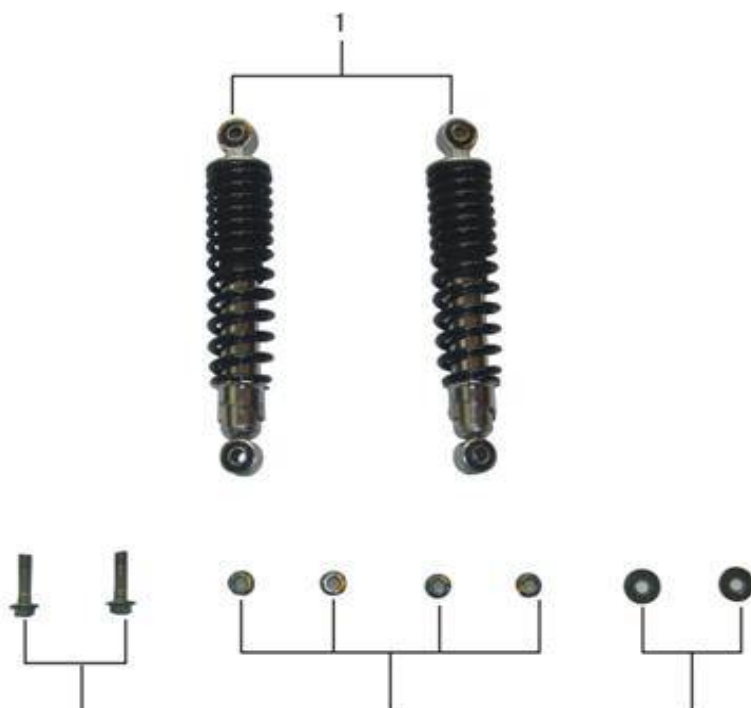

|
2|
3|
4

No.	code	description	quantity
1	ZW-T-01	rear absorbs	2pc
2	M10x1.25x40	bolt flangle	2pc
3	M10x1.25	flangle nut	4pc
4	f 10xf 28x2	washer	2pc

U: side stander



No.	code	description	quantity
1	ZW-U-01	side stander	1pc
2	ZW-U-02	spring	1pc
3	ZW-U-03	spring	1pc
4	M8x20	bolt	1pc

V: center stander



5

4

No.	code	description	quantity
1	ZW-V-01	center stander	1pc
2	ZW-V-02	cushion	1pc
3	ZW-V-03	spring	1pc
4	M10x1.25x25	bolt flange	2pc
5	ZW-V-05	spacer	2pc

W: front cover, frong light

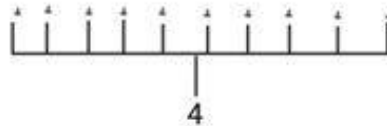

No.	code	description	quantity
1	ZW-W-01	front cover	1pc
2	ZW-W-02	front-under cover	1pc
3	ZW-W-03	front light	1pc
4	ST4.2x10	screw	10pc

X: rear carrier



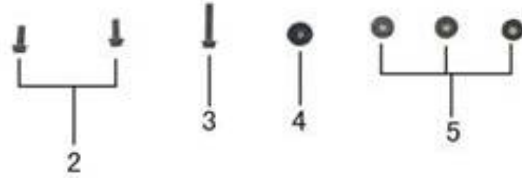

No.	code	description	quantity
1	ZW-X-01	rear carrier	1pc
2	M6x16	bolt flange	2pc
3	M6x16	bolt flange	1pc
4	f 6xf 18x4	rubber cushion	1pc
5	f 6xf 18x1.5	washer	3pc

Y: battery box, battery, wire, socket, fuse

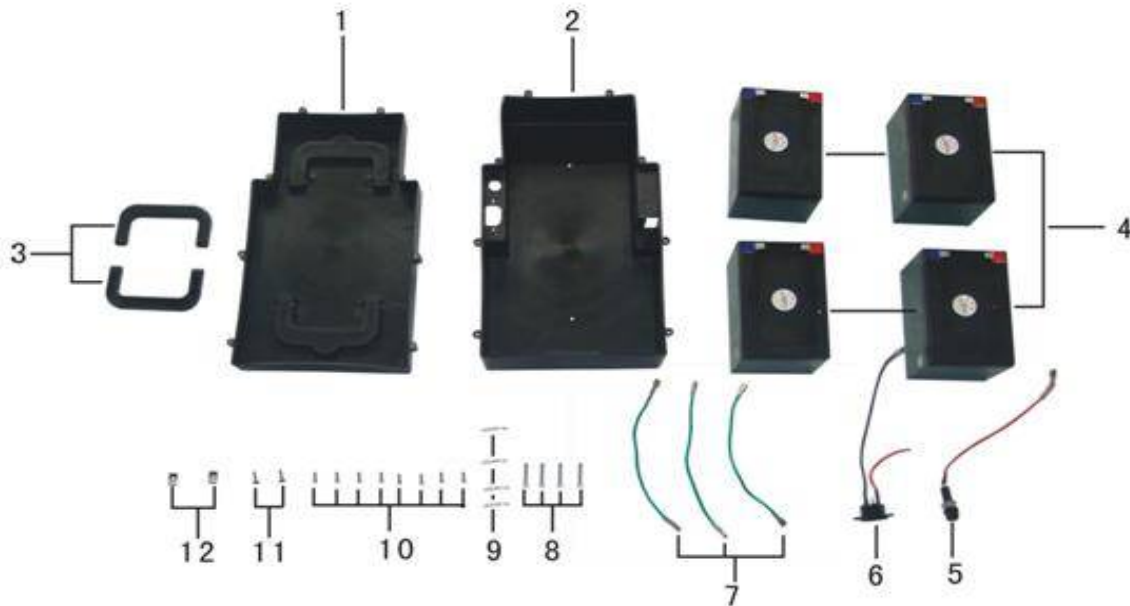

No.	code	description	quantity
1	ZW-Y-01	up cover battery box	1pc
2	ZW-Y-02	under cover battery box	1pc
3	ZW-Y-03	battery box handle	2pc
4	ZW-Y-04	battery	4pc

5	ZW-Y-05	fuse set(30A)	1pc
6	ZW-Y-06	plugs	1pc
7	ZW-Y-07	wires	3pc
8	ZW-Y-08	pin	4pc
9	ZW-Y-09	nog	4pc
10	M4x12	screw	8pc
11	ST4.2x16	screw	2pc
12	ST4.2	washer	2pc

Z: rear fork fender

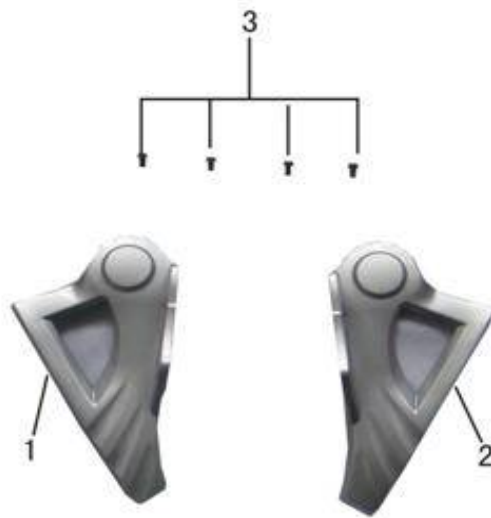

No.	code	description	quantity
1	ZW-Z-01	left rear fork fender	1pc
2	ZW-Z-02	right rear fork fender	1pc
3	M6x12	bolt flange	4pc